

MMI

**D-SUB CONNECTOR
(STRADDLE MOUNT TYPE)**

D-SUBMINIATURE CLASSIFICATION



* RIGHT ANGLE D-SUB(Pa)
DB 1XX SERIES

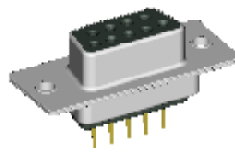

* STRAIGHT D-SUB(P)
DB 2XX SERIES

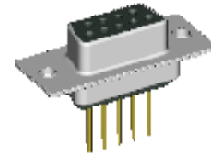

* WIRING D-SUB(W)
DB 3XX SERIES

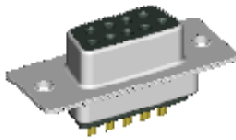

* SOLDER CUP D-SUB(Sc)
DB 4XX SERIES

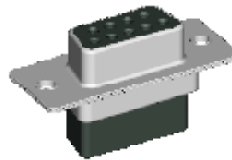

* CRIMP D-SUB(Cr)
DB 5XX SERIES

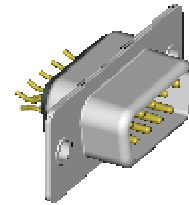

* STRADDLE D-SUB(Ste)
DB 6XX SERIES

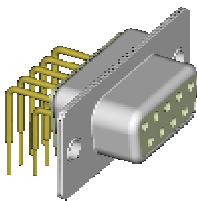

* MACHINE PIN D-SUB
DB 9XX SERIES

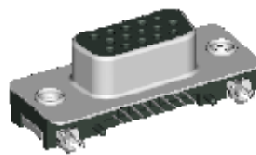

* HIGH DENSITY D-SUB
HDB SERIES

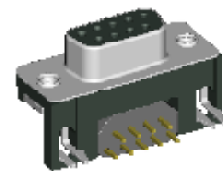

* EMI D- SUB
EDB & EHDB SERIES

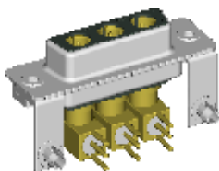

* COMBO D-SUB
CDB SERIES



* IDC D-SUB
IDB SERIES

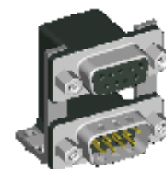

* STACK D-SUB
SDB SERIES

NOTE : SOME SIZES, STYLES AND OPTION ARE NON-STANDARD, NON-CANCELLABLE, NON-RETURNABLE

DB1XX SERIES MOUNTING OPTIONS

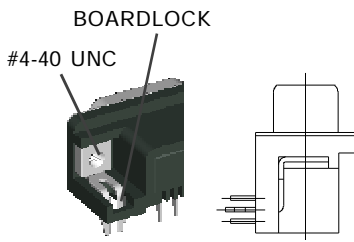

a TYPE
WITH #4-40UNC THREAD INSERT
GROUNDING BRACKET &
BOARDLOCK

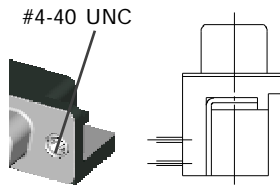

b TYPE
WITH #4-40UNC THREAD INSERT
GROUNDING BRACKET

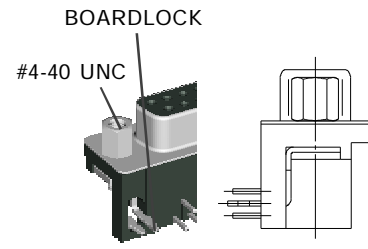

c TYPE
WITH FIXED #4-40UNC HEX NUT
GROUNDING BRACKET &
BOARDLOCK

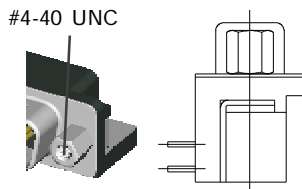

d TYPE
WITH FIXED #4-40UNC HEX NUT
GROUNDING BRACKET

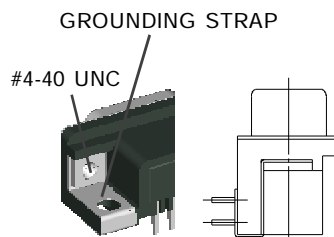

e TYPE
WITH #4-40UNC THREAD INSERT
GROUNDING STRAP

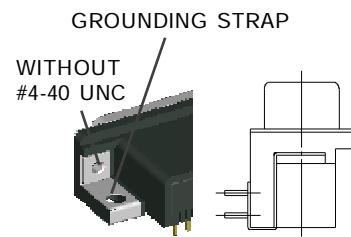

en TYPE
WITHOUT #4-40UNC THREAD INSERT
WITH GROUNDING STRAP

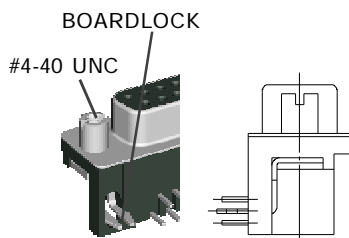

rc TYPE
WITH FIXED #4-40UNC ROUND NUT
GROUNDING BRACKET &
BOARDLOCK

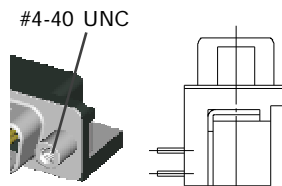

rd TYPE
WITH FIXED #4-40UNC ROUND NUT
GROUNDING BRACKET

NOTE : SOME SIZES, STYLES AND OPTION ARE NON-STANDARD, NON-CANCELLABLE, NON-RETURNABLE

DB 2XX SERIES MOUNTING OPTIONS

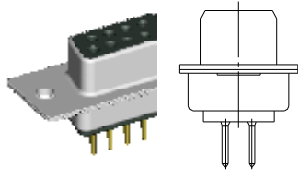

H TYPE
WITH MOUNTING HOLE ONLY

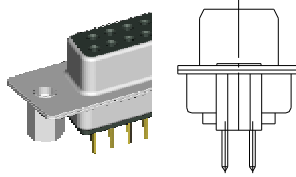

I TYPE
WITH #4-40UNC HEX NUT
IN THE REAR OF THE SHELL

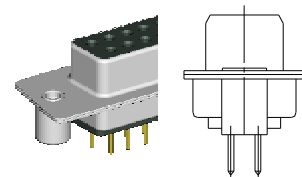

J TYPE
WITH #4-40UNC ROUND NUT
IN THE REAR OF THE SHELL

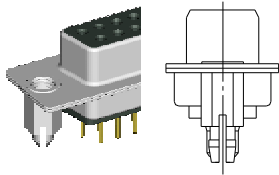

K TYPE
WITH #4-40UNC IN THE REAR SHELL
USE RIVET AS BOARDLOCK

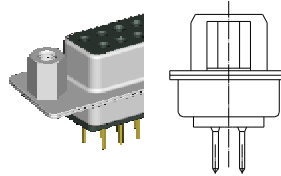

L TYPE
WITH #4-40UNC HEX NUT
IN THE FRONT OF THE SHELL

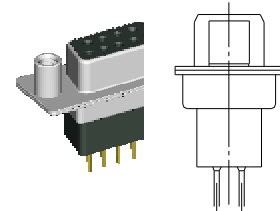

M TYPE
WITH #4-40UNC ROUND NUT
IN THE FRONT OF THE SHELL

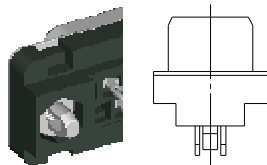

P TYPE
WITH #4-40UNC IN THE REAR SHELL
USE PRESS FIT BOARDLOCK

NOTE : SOME SIZES, STYLES AND OPTION ARE NON-STANDARD, NON-CANCELLABLE, NON-RETURNABLE

D-SUB CONNECTOR PART NO. INFORMATION

DB **XXX** - **X** **X** **XX** **GX** - **X** **X**

D-SUB CONNECTOR

GENDER

M: MALE
F: FEMALE

NO. OF CONTACT

09,15,25,37,50

PCB or TERMINAL TYPE

Pa: RIGHT ANGLE TYPE
P: STRAIGHT TYPE
W: WIRE TYPE
Sc: SOLDER CUP TYPE
Cr: CRIMP TYPE
Ste: STRADDLE MOUNT TYPE

BOARDLOCK OPTION

X: WITHOUT PRONG BOARD
2: 2 PRONG BOARD LOCK
4: 4 PRONG BOARD LOCK

CONTACT PLATING OPTION

Gf: GOLD FLASH
G30: 30u" GOLD PLATING
Gft: GOLD FLASH ON CONTACT, TIN PLATED ON SOLDER TAIL
G15t: 15u" GOLD ON CONTACT, TIN PLATED ON SOLDER TAIL
G30t: 30u" GOLD ON CONTACT, TIN PLATED ON SOLDER TAIL

SERIES NO.

1XX: RIGHT ANGLE TYPE
-100: FOOTPRINT= 8.08 mm
-120: FOOTPRINT= 14.84 mm
-121: FOOTPRINT= 8.00 mm
-131: FOOTPRINT= 1.60 mm
-132: FOOTPRINT= 1.20 mm
-160: FOOTPRINT= 5.08 mm

2XX: STRAIGHT TYPE
-200: LENTH= 4.85 mm
-210: LENTH= 5.00 mm
-250: PRESS FIT PCB TYPE

3XX: WIRE TYPE
-300: LENTH= 10.50 mm
-310: LENTH= 13.50 mm
-320: LENTH= 17.50 mm

4XX: SOLDER CUP TYPE
- 400

5XX: CRIMP TYPE
- 500

6XX: STRADDLE MOUNT TYPE
-600

9XX: MACHINE PIN TYPE
-900: FOOTPRINT= 8.00 mm
-910: FOOTPRINT= 10.20 mm
-930: FOOTPRINT= 8.19 mm
-931: FOOTPRINT= 10.39 mm

MOUNTING TYPE

FOR RIGHT ANGLE TYPE
a :WITH #4-40UNC THREAD INSERT GROUNDING BRACKET & BOARDLOCK
an: WITHOUT #4-40UNC THREAD INSERT GROUNDING BRACKET & BOARDLOCK
b: WITH #4-40UNC THREAD INSERT GROUNDING BRACKET
c: WITH FIXED #4-40UNC HEX NUT GROUNDING BRACKET & BOARDLOCK
d: WITH FIXED #4-40UNC HEX NUT GROUNDING BRACKET
e : WITH #4-40UNC THREAD INSERT GROUNDING STRAP
en: WITHOUT #4-40UNC THREAD INSERT WITH GROUNDING STRAP
rc: WITH FIXED #4-40UNC ROUND NUT GROUNDING BRACKET & BOARDLOCK
rd: WITH FIXED #4-40UNC ROUND NUT GROUNDING BRACKET

FOR STRAIGHT TYPE
H: WITH MOUNTING HOLE ONLY
I: WITH #4-40UNC HEX NUT IN THE REAR OF THE SHELL
J: WITH #4-40UNC ROUND NUT IN THE REAR OF THE SHELL
K: WITH #4-40UNC IN THE REAR SHELL USE RIVET AS BOARDLOCK
L: WITH #4-40UNC HEX NUT IN THE FRONT OF THE SHELL
M: WITH #4-40UNC ROUND NUT IN THE FRONT OF THE SHELL
JP: WITH #4-40UNC ROUND NUT WITH PLASTIC INSERT IN THE REAR OF THE SHELL
P: WITH #4-40UNC IN THE REAR SHELL USE PRESS FIT BOARDLOCK

NOTE : SOME SIZES, STYLES AND OPTION ARE NON-STANDARD, NON-CANCELLABLE, NON-RETURNABLE

D-SUB 600 SERIES *MOUNTING TYPE H & I* STRADDLE TYPE - Ste

MOUNTING TYPE H

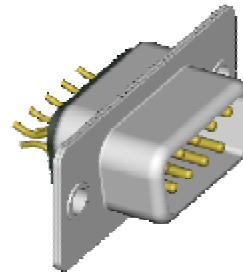
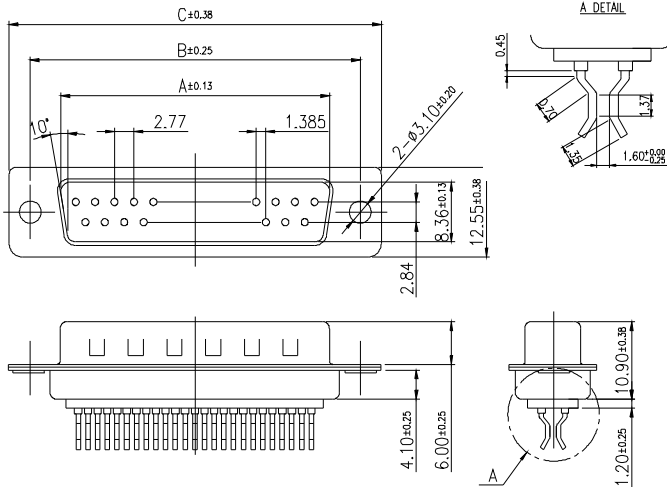

PART NO.	NO.OF CONTACTS (SHELL SIZE)	DIMENSION		
		A	B	C
DB600-SteM09Gf-H	9P	16.92	24.99	30.81
DB600-SteM15Gf-H	15P	25.50	33.32	39.14
DB600-SteM25Gf-H	25P	38.96	47.04	53.04
DB600-SteM37Gf-H	37P	55.42	63.50	69.32

MOUNTING TYPE I

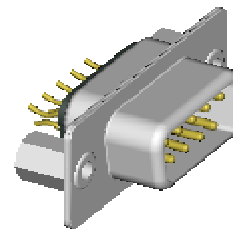
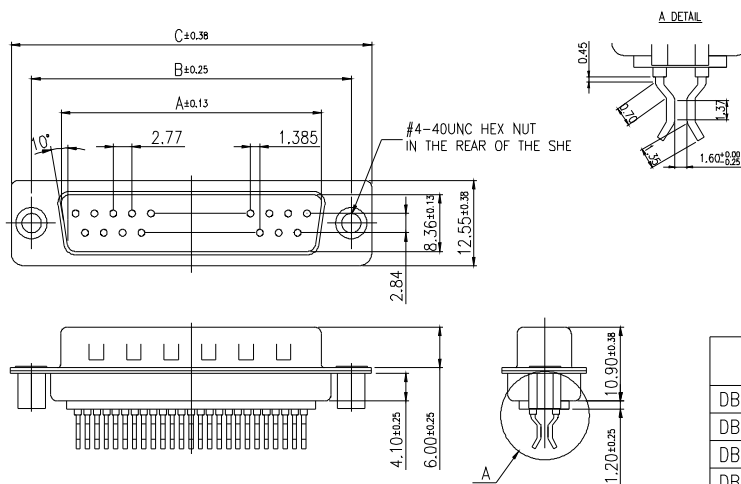

PART NO.	NO.OF CONTACTS (SHELL SIZE)	DIMENSION		
		A	B	C
DB600-SteM09Gf-I	9P	16.92	24.99	30.81
DB600-SteM15Gf-I	15P	25.50	33.32	39.14
DB600-SteM25Gf-I	25P	38.96	47.04	53.04
DB600-SteM37Gf-I	37P	55.42	63.50	69.32

DB	600	Ste	M	XX	GX	H & I
SERIES NO. 600		GENDER M: MALE		NO. OF CONTACT 09, 15, 25, 37		
D-SUB CONNECTOR		PCB TYPE STRADDLE MOUNT TYPE		CONTACT PLATING OPTION Gf: GOLD FLASH		H: WITH MOUNTING HOLE ONLY I: WITH #4-40UNC HEX NUT IN THE REAR OF THE SHELL

ELECTRICAL CHARACTERISTIC

CONTACT CURRENT RATING: 1A
 CONTACT RESISTANCE 25 mOHM MAX
 INSULATION RESISTANCE: 5000 MOHM MIN. AT DC 500V
 DIELECTRIC WITHSTANDING VOLTAGE: AC 1000V 1 MINUTE
 OPERATING TEMPERATURE:-55°C~ +105°C

MECHANICAL CHARACTERISTICS

CONTACT INSERTION FORCE: 341 g MAX.
 CONTACT SEPARATION FORCE: 21 g MIN.

MATERIALS

INSULATOR: P.B.T UL 94V-0 RATED
 SHELL: COLD ROLLER STEEL
 CONTACTS: BRASS

NOTE : SOME SIZES, STYLES AND OPTION ARE NON-STANDARD, NON-CANCELLABLE, NON-RETURNABLE

D-SUB 600 SERIES *MOUNTING TYPE J & L* STRADDLE TYPE - Ste

MOUNTING TYPE K

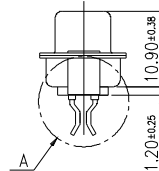
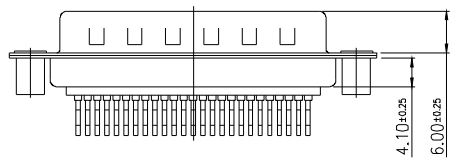
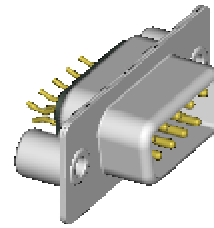
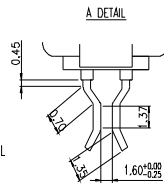
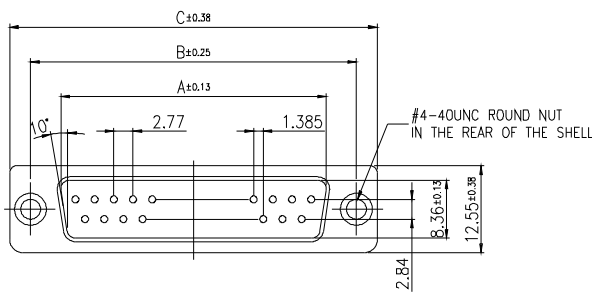

PART NO.	NO.OF CONTACTS (SHELL SIZE)	DIMENSION		
		A	B	C
DB600-SteM09Gf-J	9P	16.92	24.99	30.81
DB600-SteM15Gf-J	15P	25.50	33.32	39.14
DB600-SteM25Gf-J	25P	38.96	47.04	53.04
DB600-SteM37Gf-J	37P	55.42	63.50	69.32

MOUNTING TYPE L

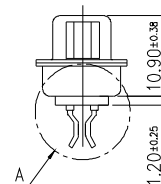
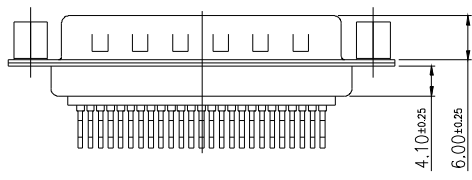
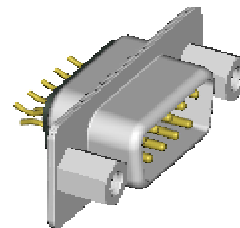
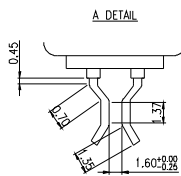
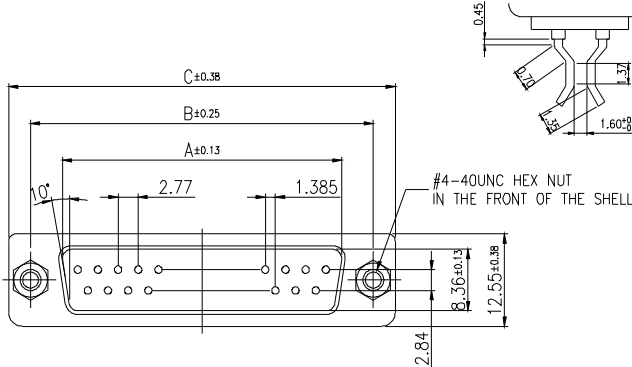

PART NO.	NO.OF CONTACTS (SHELL SIZE)	DIMENSION		
		A	B	C
DB600-SteM09Gf-L	9P	16.92	24.99	30.81
DB600-SteM15Gf-L	15P	25.50	33.32	39.14
DB600-SteM25Gf-L	25P	38.96	47.04	53.04
DB600-SteM37Gf-L	37P	55.42	63.50	69.32

DB	600	Ste	M	XX	GX	J & L
D-SUB CONNECTOR		SERIES NO. 600		GENDER M: MALE		NO. OF CONTACT 09, 15, 25, 37
PCB TYPE STRADDLE MOUNT TYPE		CONTACT PLATING OPTION Gf: GOLD FLASH				MOUNTING TYPE J: WITH #4-40UNO ROUND NUT IN THE REAR OF THE SHELL L: WITH #4-40UNO HEX NUT IN THE FRONT OF THE SHELL

ELECTRICAL CHARACTERISTIC

CONTACT CURRENT RATING: 1A
 CONTACT RESISTANCE 25 mOHM MAX
 INSULATION RESISTANCE: 5000 MOHM MIN. AT DC 500V
 DIELECTRIC WITHSTANDING VOLTAGE: AC 1000V 1 MINUTE
 OPERATING TEMPERATURE: -55°C - +105°C

MECHANICAL CHARACTERISTICS

CONTACT INSERTION FORCE: 341 g MAX.
 CONTACT SEPARATION FORCE: 21 g MIN.

MATERIALS

INSULATOR: P.B.T UL 94V-0 RATED
 SHELL: COLD ROLLER STEEL
 CONTACTS: BRASS

NOTE : SOME SIZES, STYLES AND OPTION ARE NON-STANDARD, NON-CANCELLABLE, NON-RETURNABLE

D-SUB 600 SERIES *MOUNTING TYPE M* STRADDLE TYPE - Ste

MOUNTING TYPE M

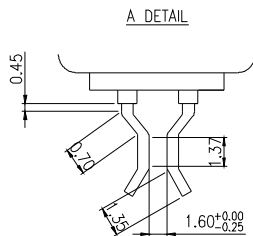
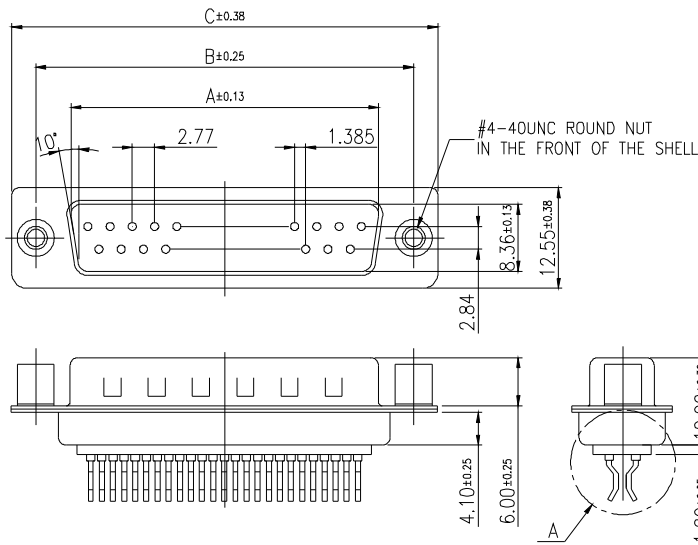
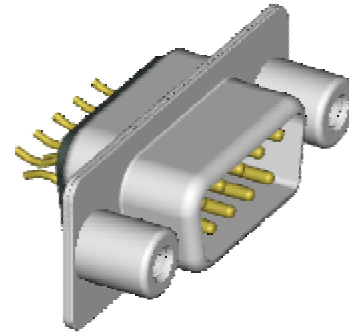

PART NO.	NO.OF CONTACTS (SHELL SIZE)	DIMENSION		
		A	B	C
DB600-SteM09Gf-M	9P	16.92	24.99	30.81
DB600-SteM15Gf-M	15P	25.50	33.32	39.14
DB600-SteM25Gf-M	25P	38.96	47.04	53.04
DB600-SteM37Gf-M	37P	55.42	63.50	69.32

DB	600	Ste	M	XX	GX	M
D-SUB CONNECTOR	SERIES NO. 600	PCB TYPE STRADDLE MOUNT TYPE	GENDER M: MALE	NO. OF CONTACT 09, 15, 25, 37	CONTACT PLATING OPTION Gf: GOLD FLASH G30: 30u" GOLD PLATING Gf: GOLD FLASH ON CONTACT, TIN PLATED ON SOLDER TAIL G15t: 15u" GOLD ON CONTACT, TIN PLATED ON SOLDER TAIL G30t: 30u" GOLD ON CONTACT, TIN PLATED ON SOLDER TAIL	MOUNTING TYPE M: WITH #4-40UNC ROUND NUT IN THE FRONT OF THE SHELL

ELECTRICAL CHARACTERISTIC
 CONTACT CURRENT RATING: 1A
 CONTACT RESISTANCE: 25 mOHM MAX
 INSULATION RESISTANCE: 5000 MOHM MIN. AT DC 500V
 DIELECTRIC WITHSTANDING VOLTAGE: AC 1000V 1 MINUTE
 OPERATING TEMPERATURE:-55°C~ +105°C

MECHANICAL CHARACTERISTICS
 CONTACT INSERTION FORCE: 341 g MAX.
 CONTACT SEPARATION FORCE: 21 g MIN.
MATERIALS
 INSULATOR: P.B.T UL 94V-0 RATED
 SHELL: COLD ROLLER STEEL
 CONTACTS: BRASS

NOTE : SOME SIZES, STYLES AND OPTION ARE NON-STANDARD, NON-CANCELLABLE, NON-RETURNABLE